

# W82903BKAG

## INSTALLATION INSTRUCTIONS SHEET

### START FROM HERE

- Make sure power is completely off at the fuse box.
- Have your fixture installed by a qualified licensed electrician
- Prepare everything in clear area.
- Wear gloves at all times during this installation.
- Read instructions carefully before you start assembly.
- Keep this instruction sheet for future reference.

**Technical Support:** 1-844-628-8368

### Please Note:

- All Matteo Lighting fixtures come with pre-wired module(s).
- Unless instructed to do so, please do not touch any part of the module(s) as any unnecessary contact with the module could cause permanent damage.

THIS LUMINAIRE MUST BE MOUNTED OR SUPPORTED INDEPENDENT OF AN OUTLET BOX

*CE LUMINAIRE NE DOIT PAS ETRE MONTE SUR UNE BOITE DE SORTIE NI SUPPORTE PAR UNE TELLE BOITE*

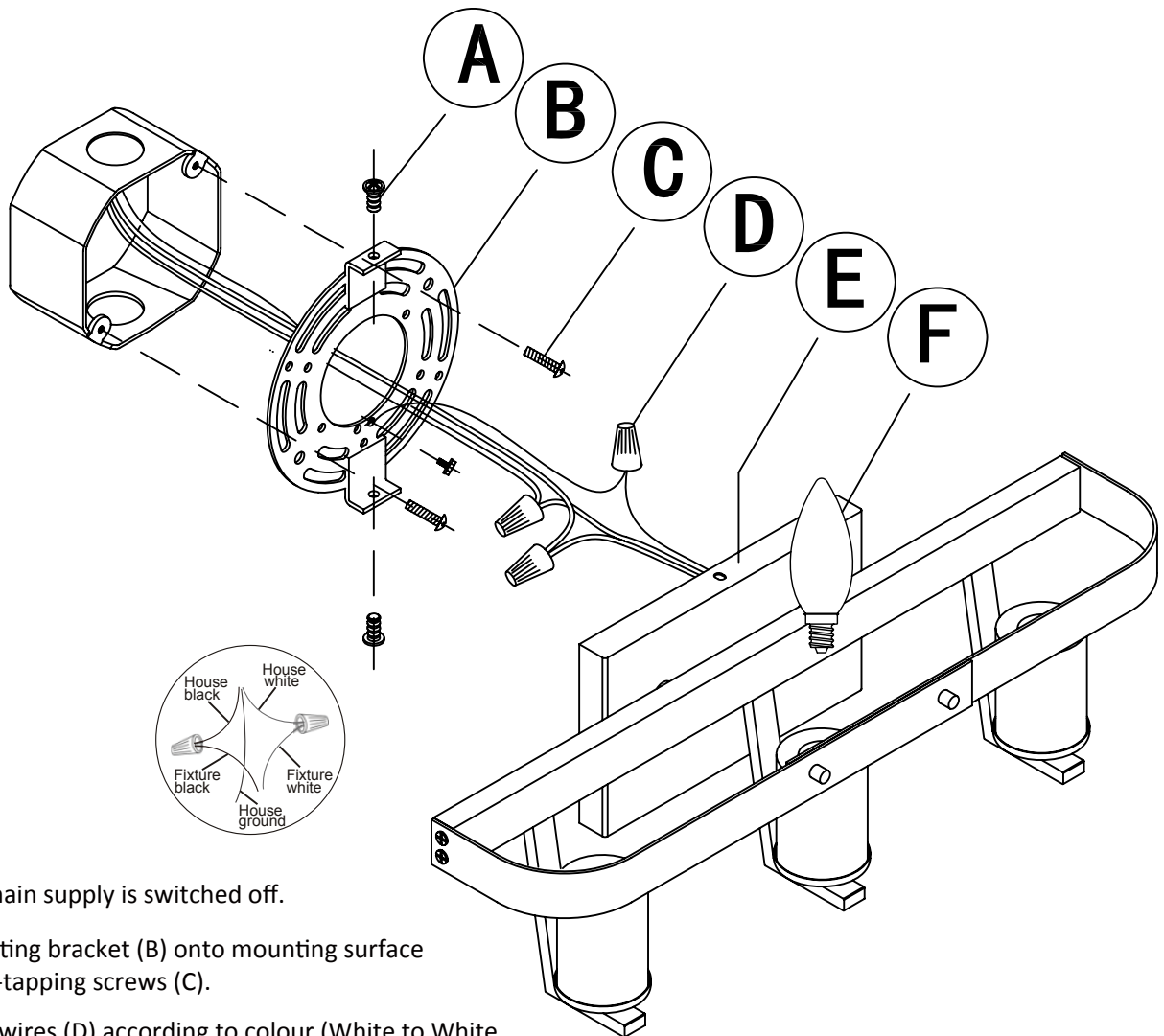

- 1 Ensure main supply is switched off.
- 2 Fit mounting bracket (B) onto mounting surface with self-tapping screws (C).
- 3 Connect wires (D) according to colour (White to White, Black to Black). Connect all earth plug together onto the crossbar with green, screw to tight.
- 4 Fit the plate (E) onto mounting bracket with flat screw (A).
- 5 Install the bulbs (F) (not included) firmly into lampholders.
- 6 Reconnect power.

### WARNING:

This fitting must be earthed.

Disconnect power and allow fitting to cool down before cleaning or changing the lamp.